

GENERAL WIRING (GENERAL WIRING-2)

FRONT UNIT

⑥

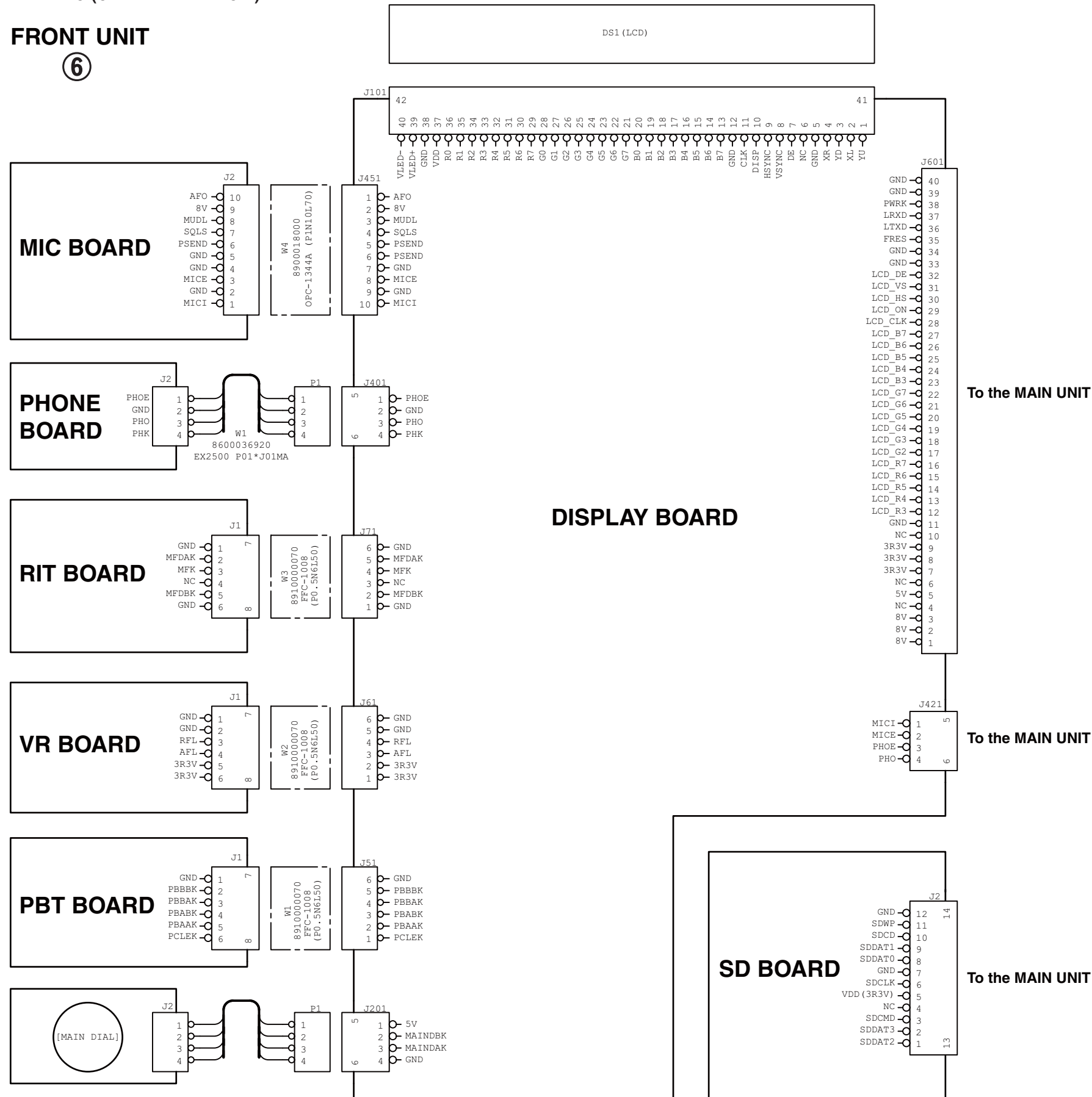

To upgrade quality, some components may be subject to change without notice.

BLOCK DIAGRAM (BLOCK DIAGRAM-1)

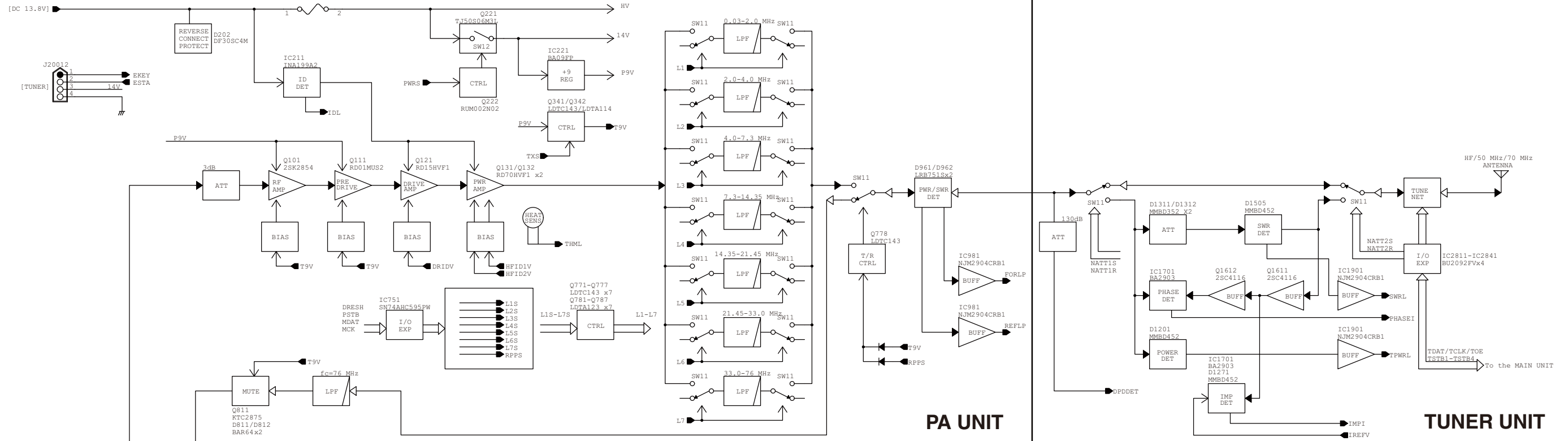

PA UNIT

TUNER UNIT

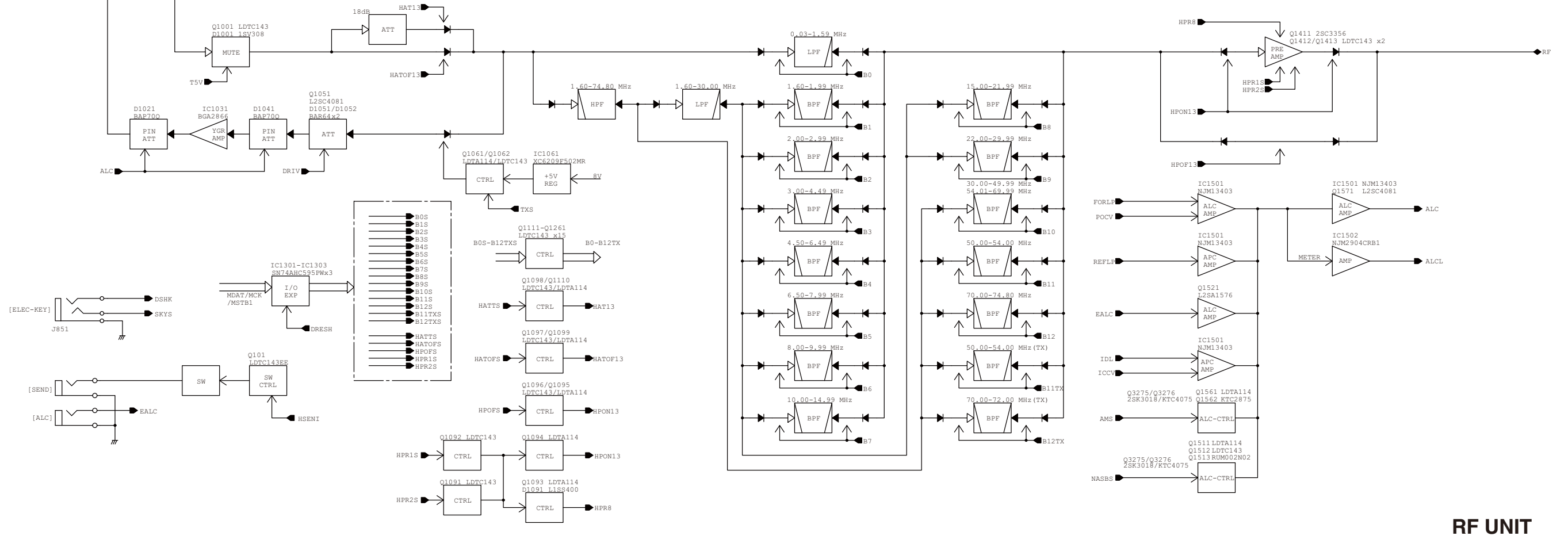

RF UNIT

To upgrade quality, some components may be subject to change without notice.

BLOCK DIAGRAM (BLOCK DIAGRAM-2)

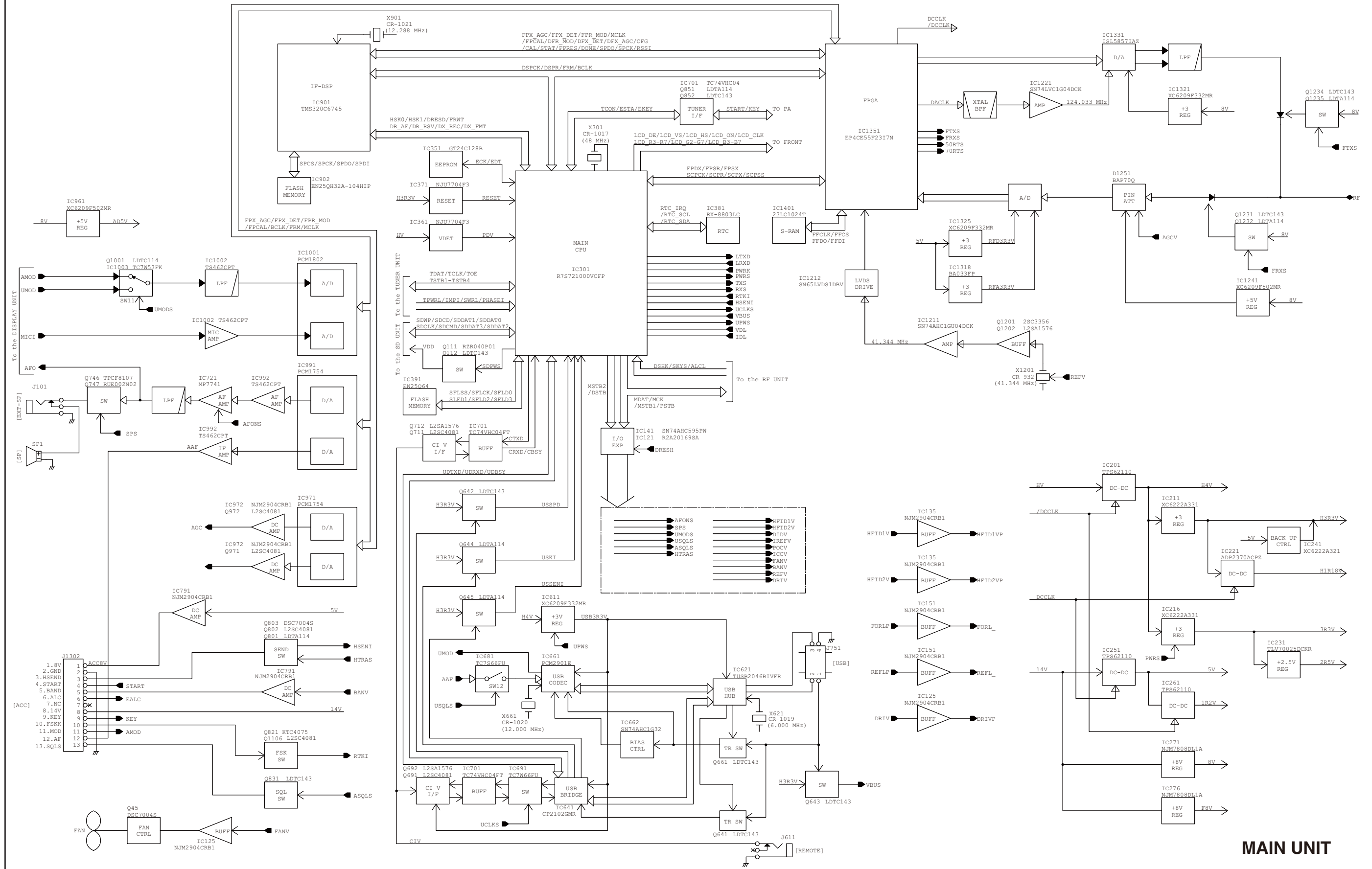

MAIN UNIT

To upgrade quality, some components may be subject to change without notice.

A-7290-3EX-②
Printed in Japan
© 2015-2016 Icom Inc.

Icom Inc.

BLOCK DIAGRAM (BLOCK DIAGRAM-3)

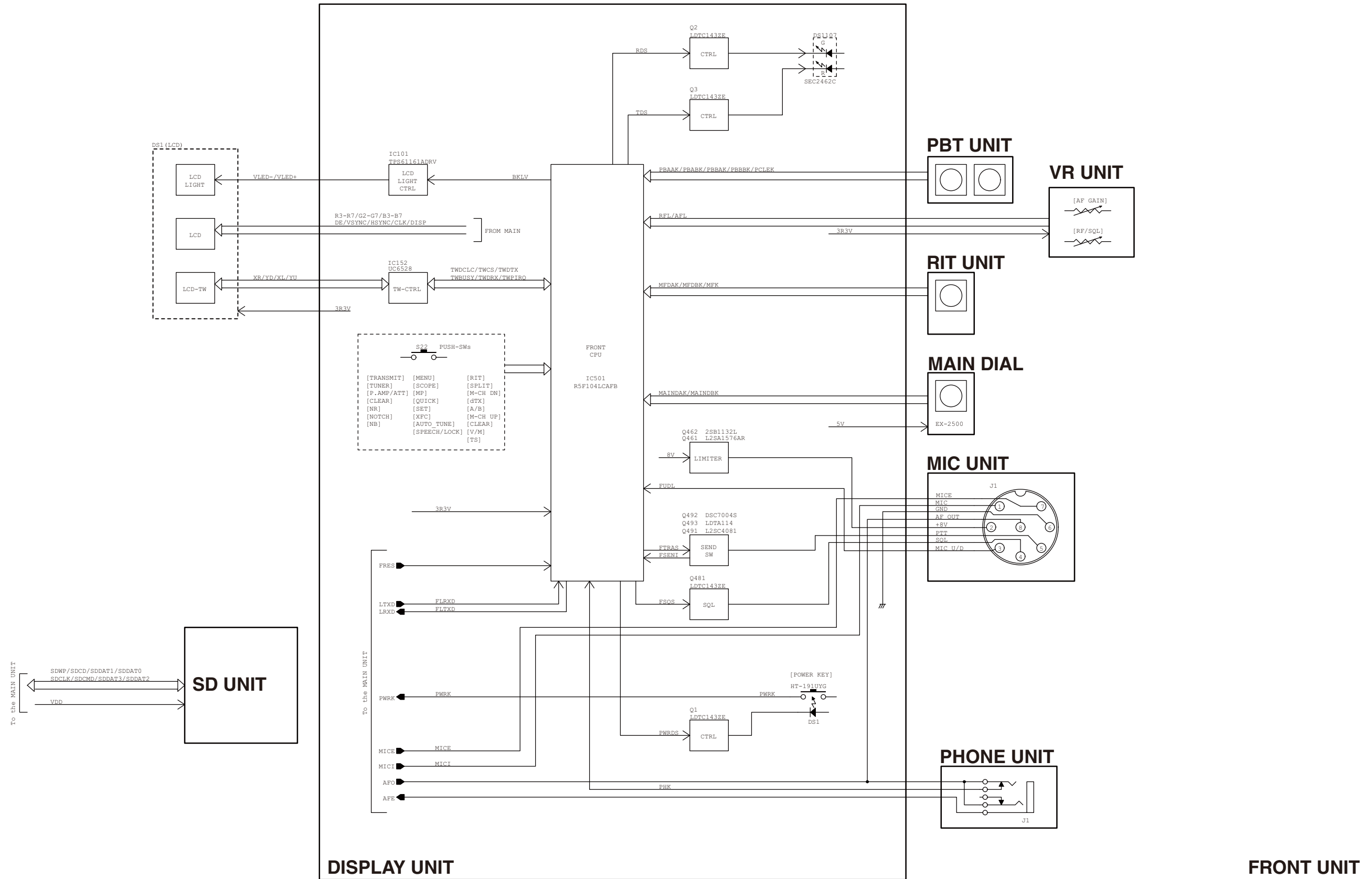

To upgrade quality, some components may be subject to change without notice.

FRONT UNIT

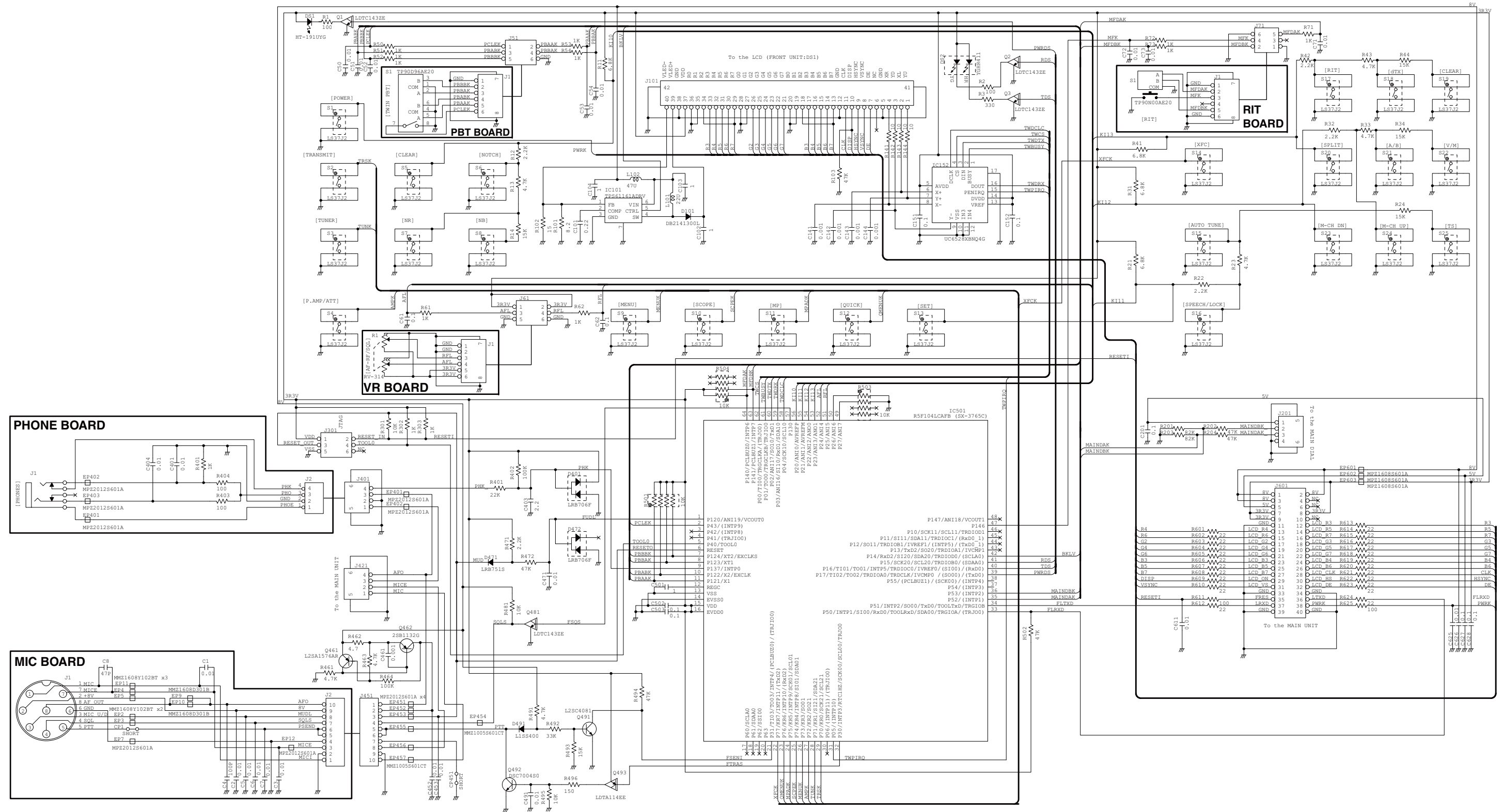

To upgrade quality, some components may be subject to change without notice.

A-7290-3EX-2
Printed in Japan
© 2015-2016 Icom Inc.

Icom Inc.

MAIN UNIT (MAIN-1)

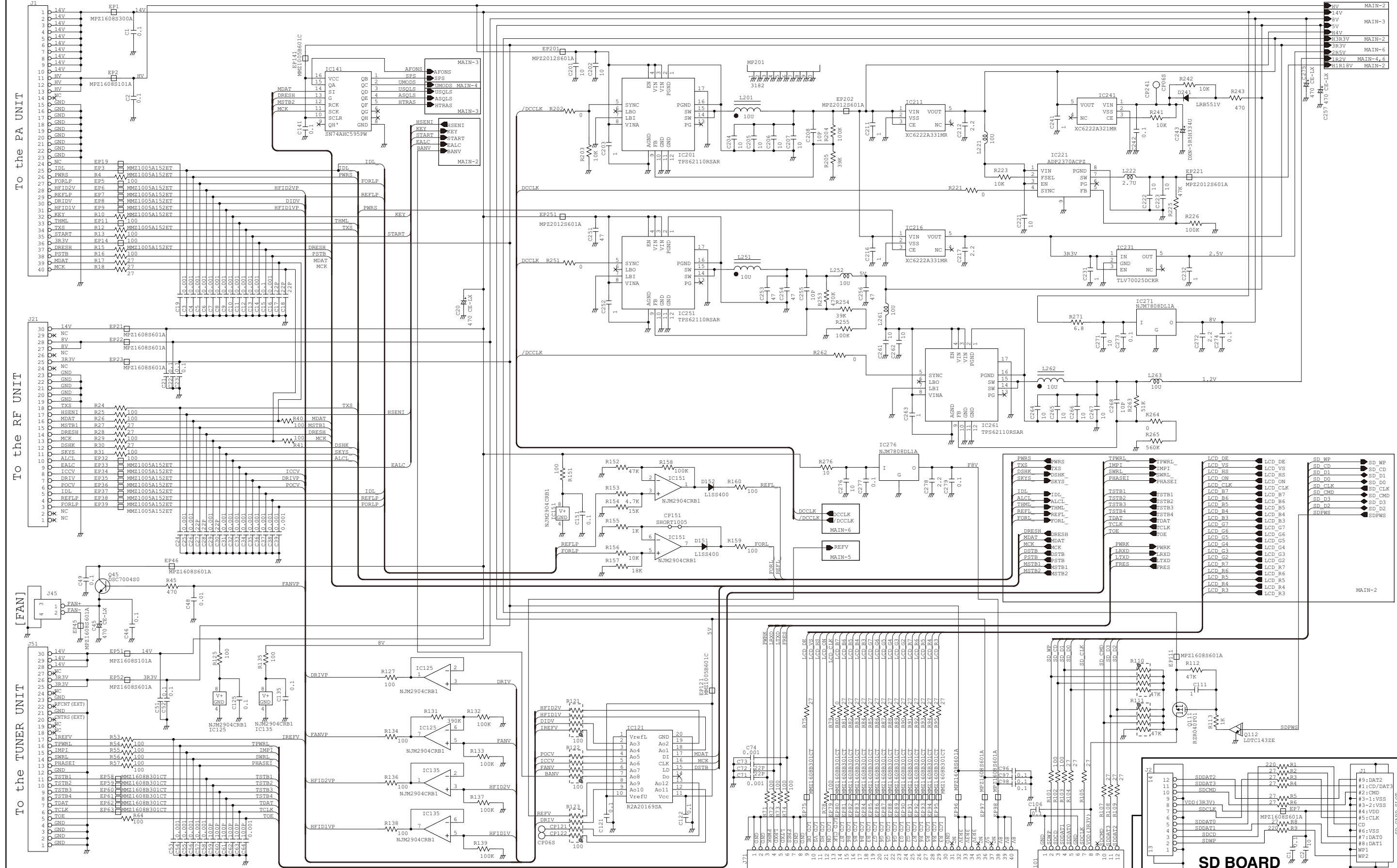

SD BOARD

To upgrade quality, some components may be subject to change without notice.

A-7290-3EX-2
Printed in Japan
© 2015-2016 Icom Inc.

Icom Inc.

MAIN UNIT (MAIN-2)

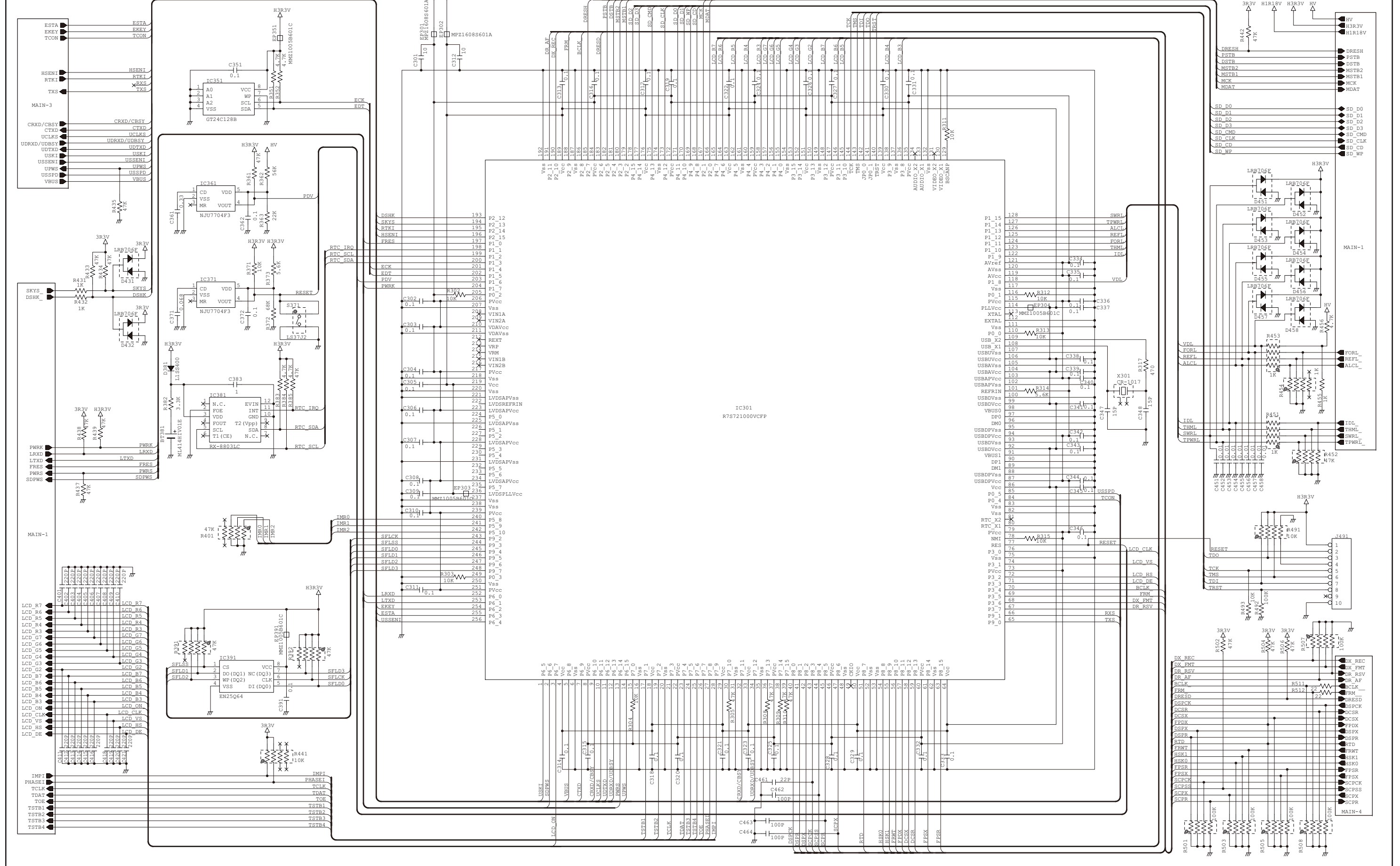

To upgrade quality, some components may be subject to change without notice.

MAIN UNIT (MAIN-4)

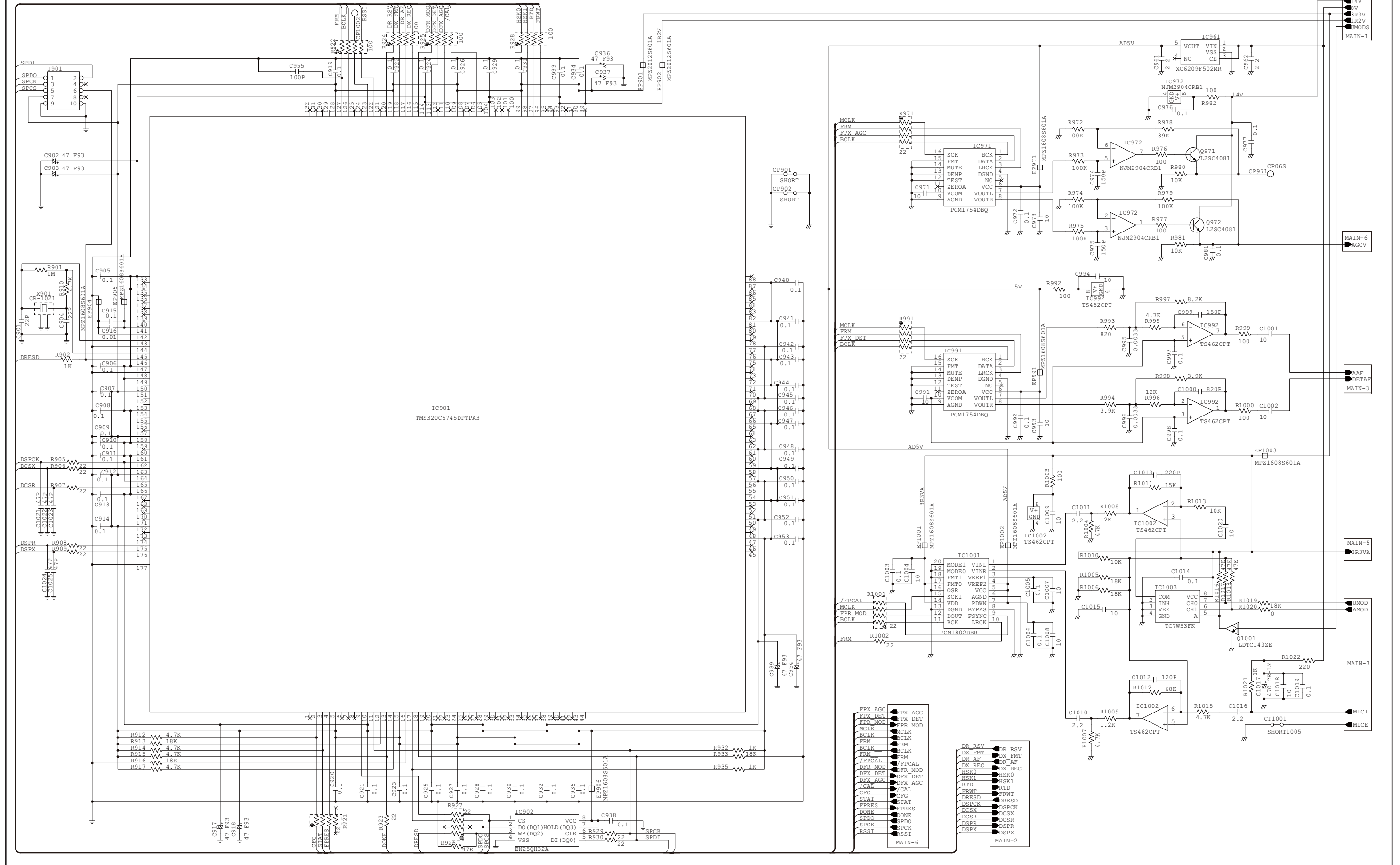

To upgrade quality, some components may be subject to change without notice.

A-7290-3EX-2
Printed in Japan
© 2015-2016 Icom Inc.

Icom Inc.

MAIN UNIT (MAIN-5)

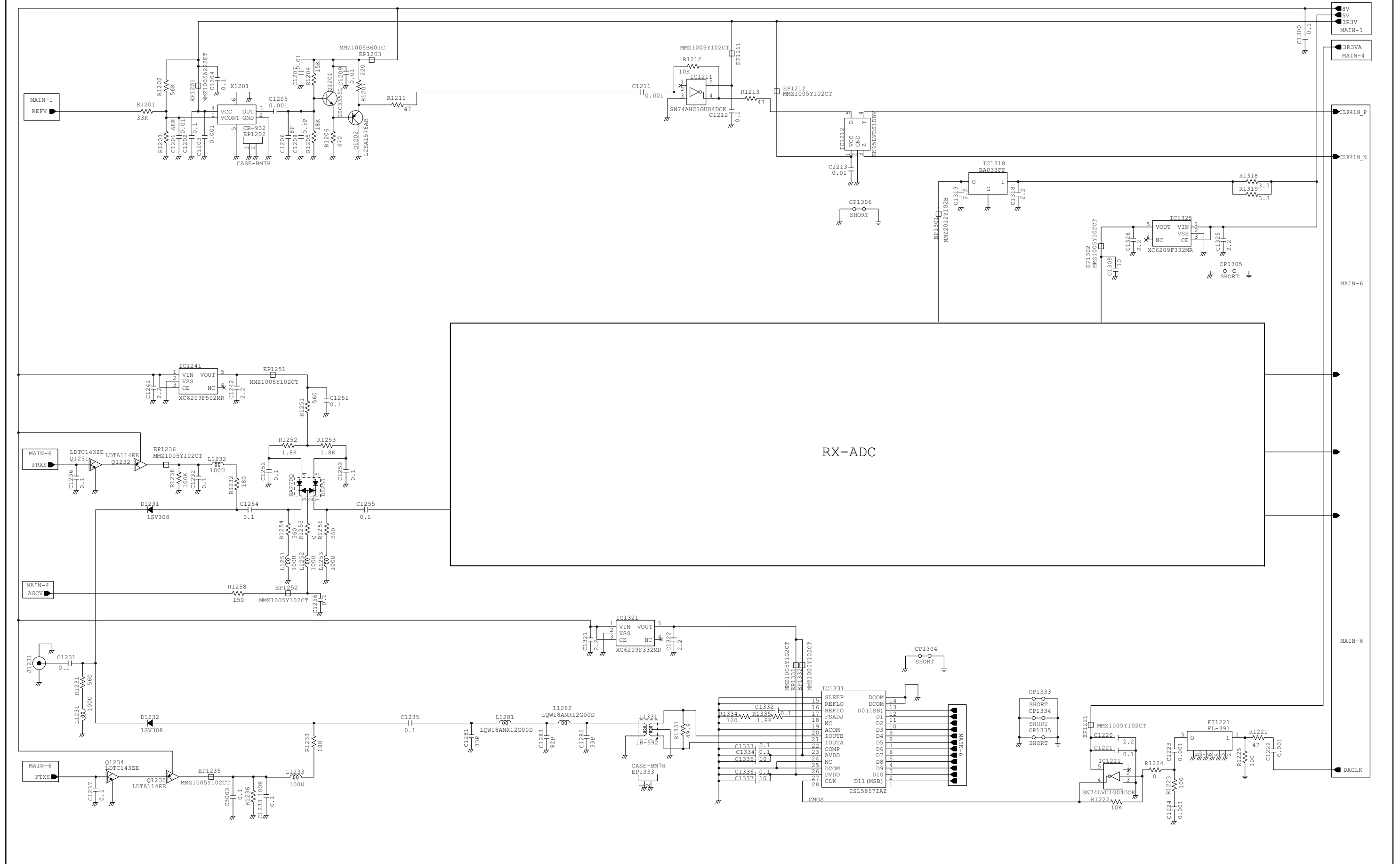

To upgrade quality, some components may be subject to change without notice.

MAIN UNIT (MAIN-6)

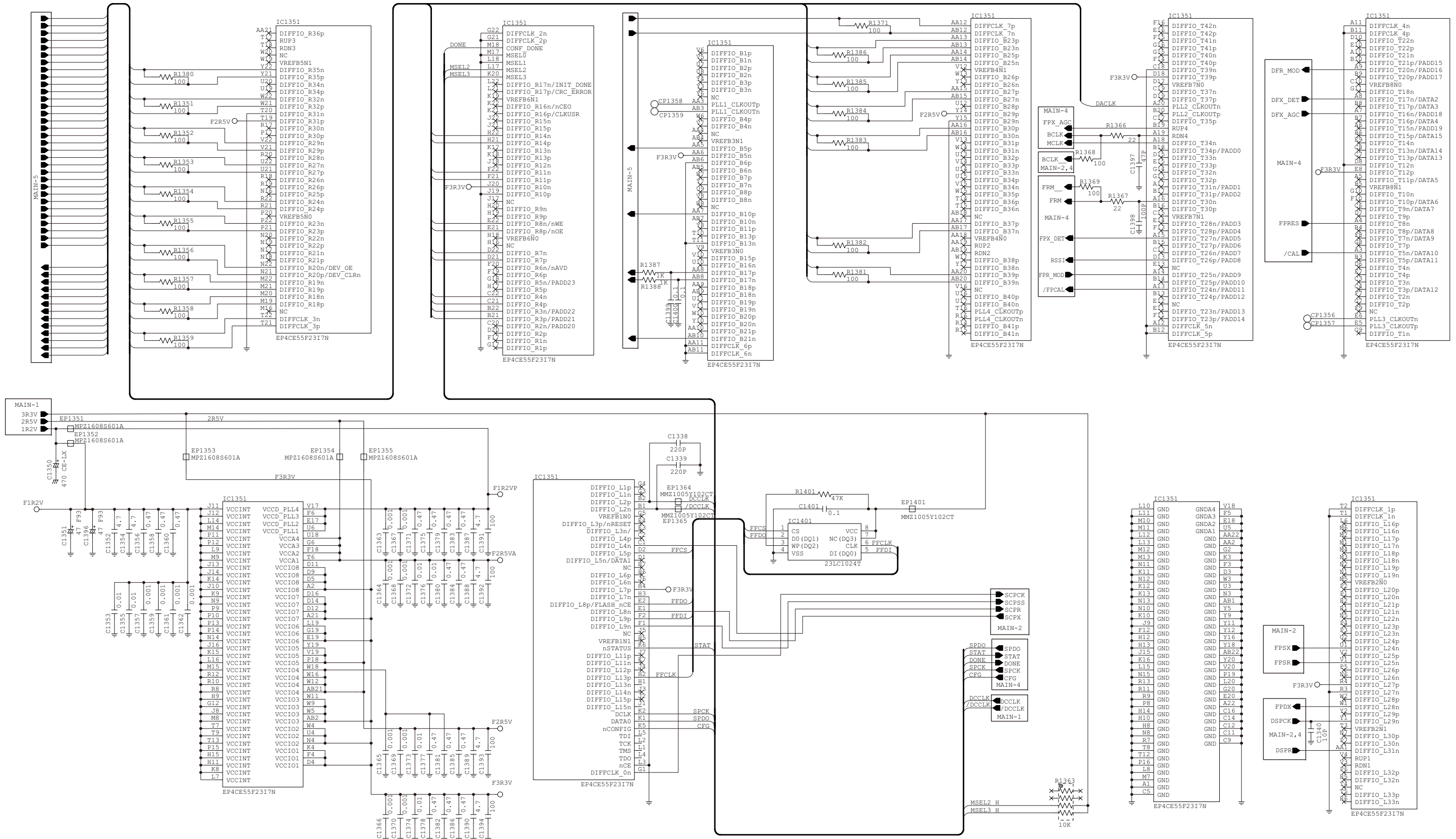

To upgrade quality, some components may be subject to change without notice.

RF UNIT

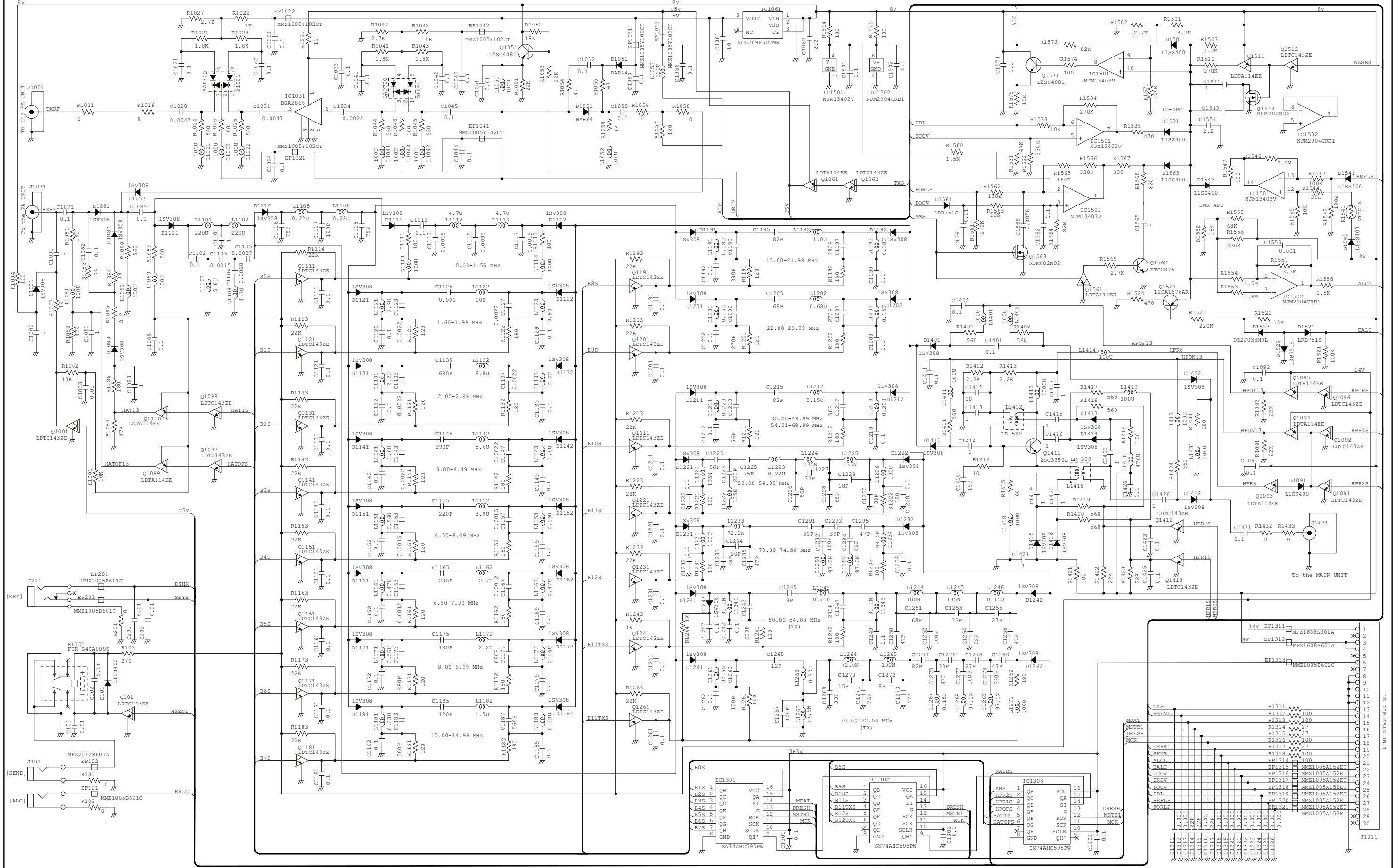

To upgrade quality, some components may be subject to change without notice.

TUNER UNIT (TUNER-1)

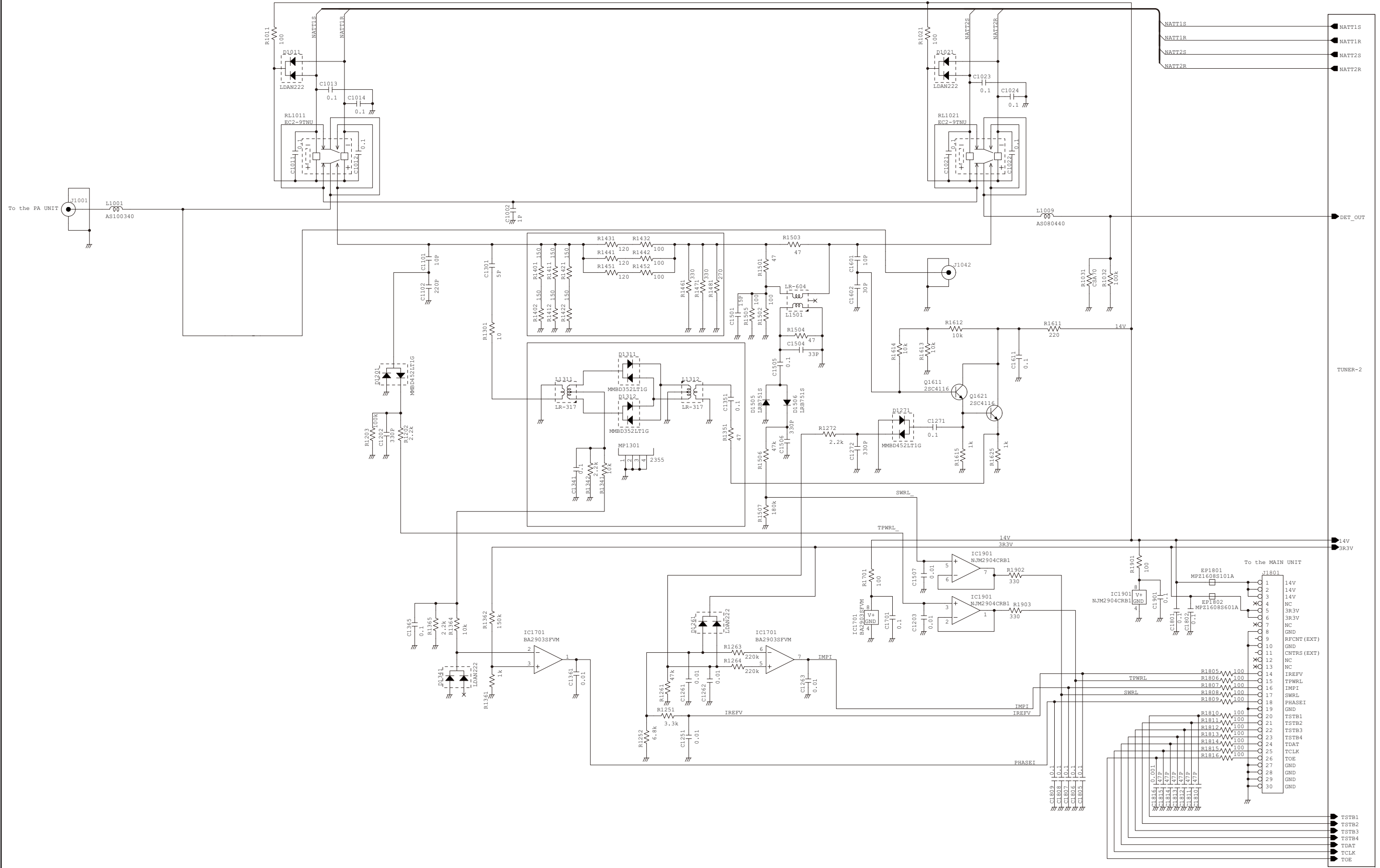

To upgrade quality, some components may be subject to change without notice.

A-7290-3EX-②
Printed in Japan
© 2015-2016 Icom Inc.

Icom Inc.

TUNER UNIT (TUNER-2)

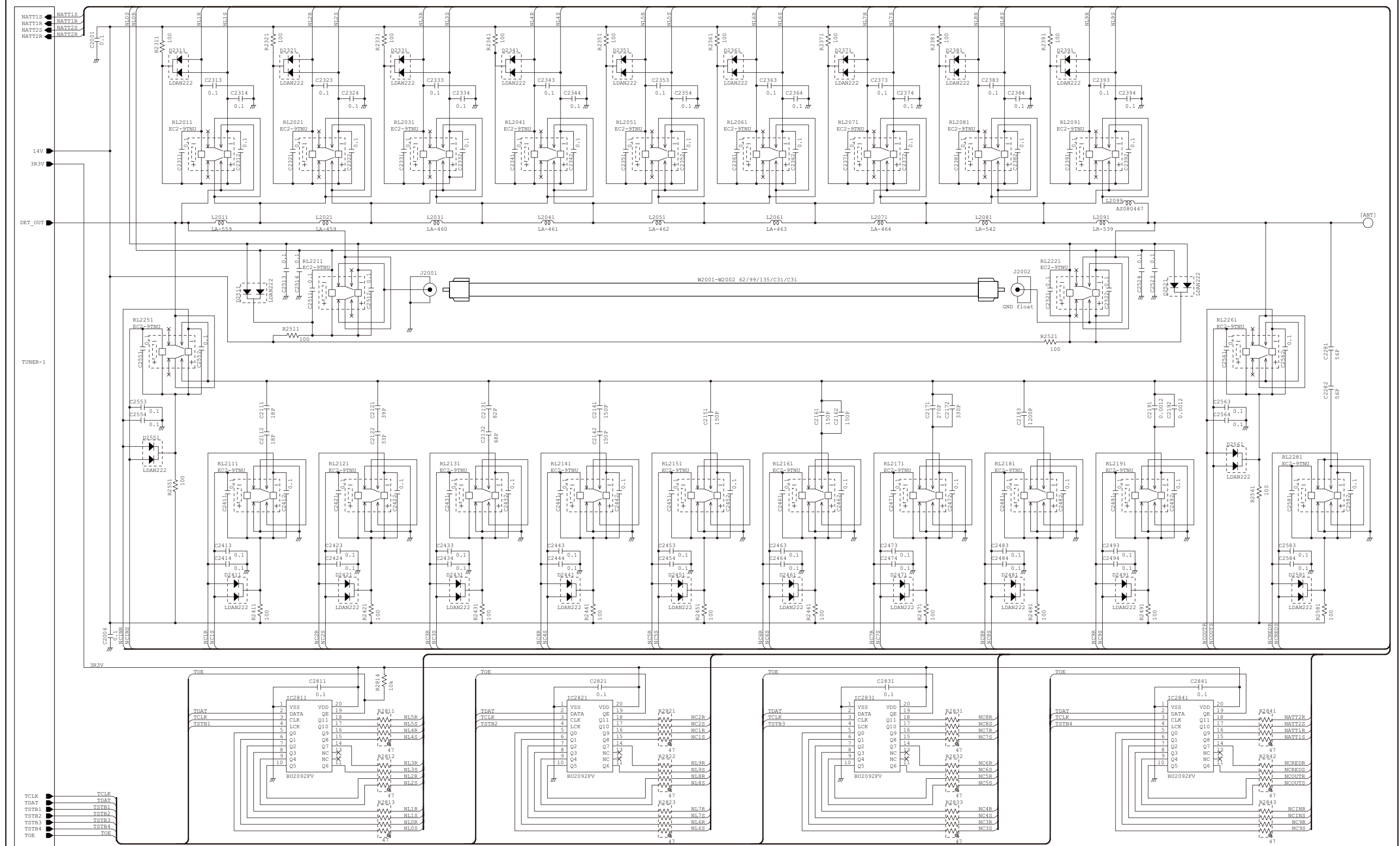

To upgrade quality, some components may be subject to change without notice.

A-7290-3EX-②
Printed in Japan
© 2015-2016 Icom Inc.

Icom Inc.

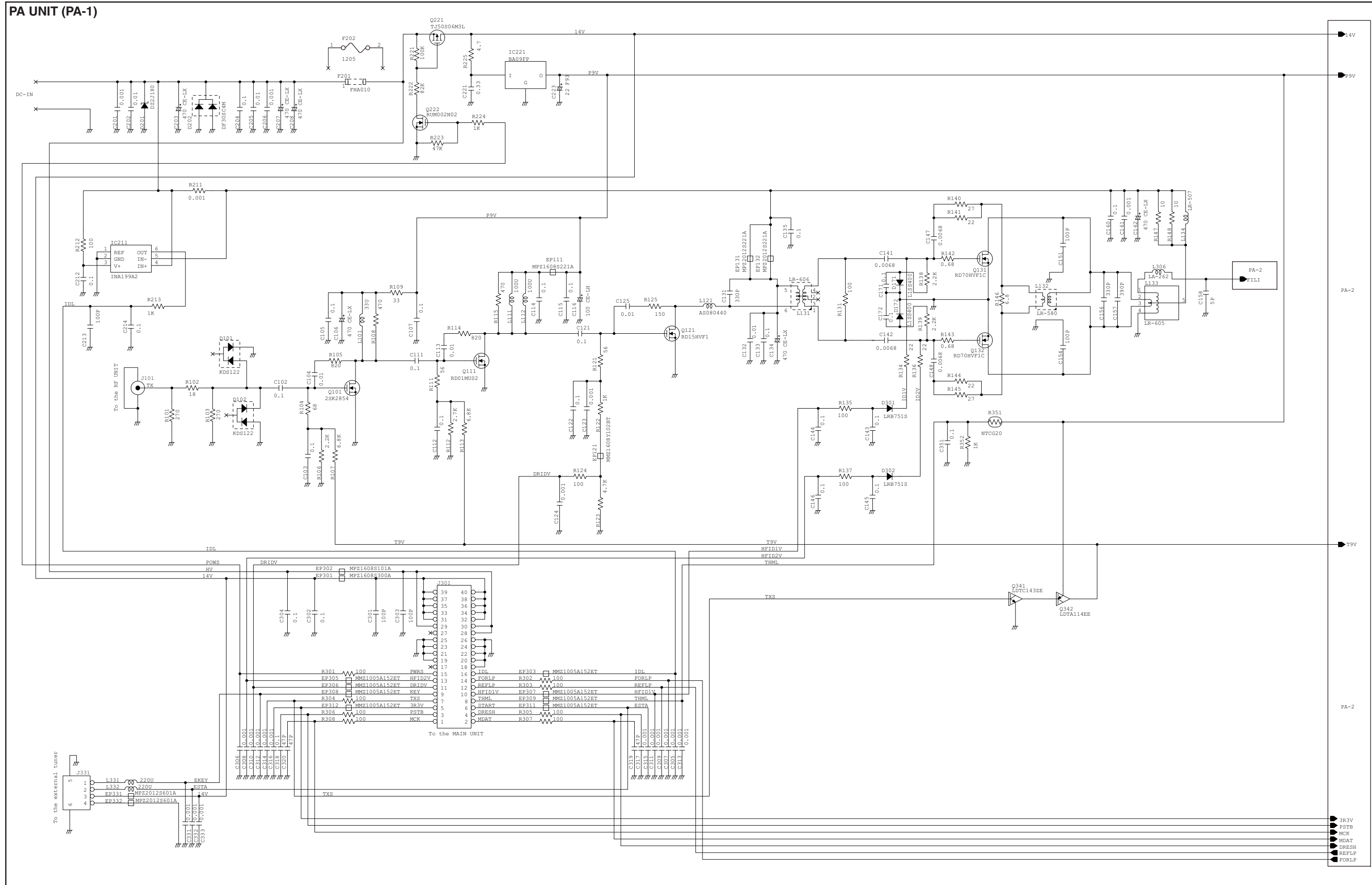

To upgrade quality, some components may be subject to change without notice.

A-7290-3EX-2
Printed in Japan
© 2015-2016 Icom Inc.

Icom Inc.

PA UNIT (PA-2)

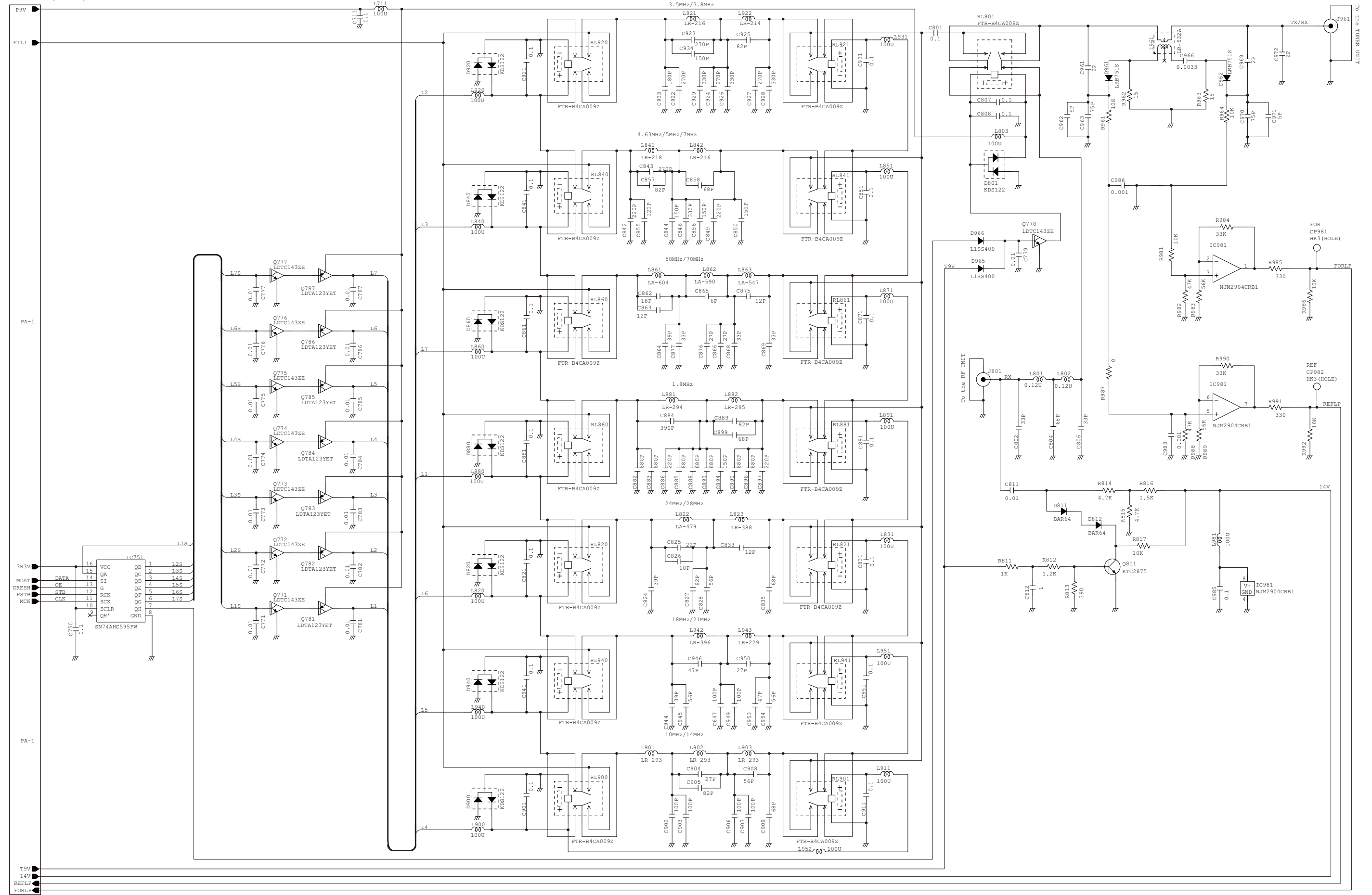

To upgrade quality, some components may be subject to change without notice.

A-7290-3EX-2
Printed in Japan
© 2015-2016 Icom Inc.